

16.1 CTV CHASSIS

Z44 820

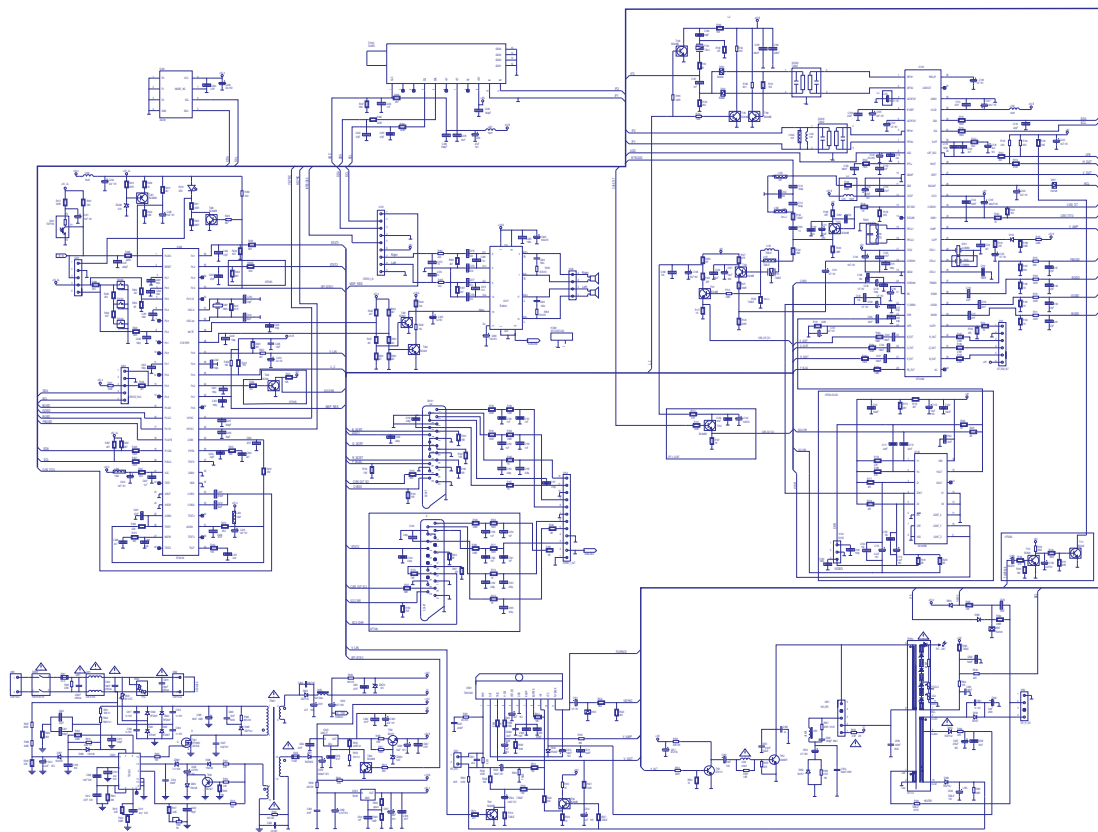

STEREO MODUL

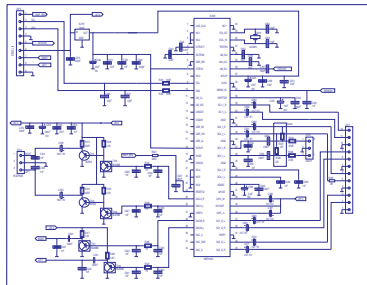

CRT BOARD

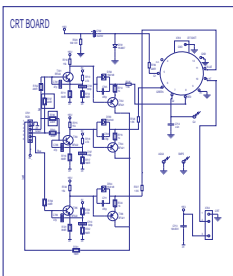

REF.	VALORE	DESCRIZIONE	Q.TA.	NOTA
1	100K	RES	1	
2	100K	RES	1	
3	100K	RES	1	
4	100K	RES	1	
5	100K	RES	1	
6	100K	RES	1	
7	100K	RES	1	
8	100K	RES	1	
9	100K	RES	1	
10	100K	RES	1	
11	100K	RES	1	
12	100K	RES	1	
13	100K	RES	1	
14	100K	RES	1	
15	100K	RES	1	
16	100K	RES	1	
17	100K	RES	1	
18	100K	RES	1	
19	100K	RES	1	
20	100K	RES	1	
21	100K	RES	1	
22	100K	RES	1	
23	100K	RES	1	
24	100K	RES	1	
25	100K	RES	1	
26	100K	RES	1	
27	100K	RES	1	
28	100K	RES	1	
29	100K	RES	1	
30	100K	RES	1	
31	100K	RES	1	
32	100K	RES	1	
33	100K	RES	1	
34	100K	RES	1	
35	100K	RES	1	
36	100K	RES	1	
37	100K	RES	1	
38	100K	RES	1	
39	100K	RES	1	
40	100K	RES	1	
41	100K	RES	1	
42	100K	RES	1	
43	100K	RES	1	
44	100K	RES	1	
45	100K	RES	1	
46	100K	RES	1	
47	100K	RES	1	
48	100K	RES	1	
49	100K	RES	1	
50	100K	RES	1	
51	100K	RES	1	
52	100K	RES	1	
53	100K	RES	1	
54	100K	RES	1	
55	100K	RES	1	
56	100K	RES	1	
57	100K	RES	1	
58	100K	RES	1	
59	100K	RES	1	
60	100K	RES	1	
61	100K	RES	1	
62	100K	RES	1	
63	100K	RES	1	
64	100K	RES	1	
65	100K	RES	1	
66	100K	RES	1	
67	100K	RES	1	
68	100K	RES	1	
69	100K	RES	1	
70	100K	RES	1	
71	100K	RES	1	
72	100K	RES	1	
73	100K	RES	1	
74	100K	RES	1	
75	100K	RES	1	
76	100K	RES	1	
77	100K	RES	1	
78	100K	RES	1	
79	100K	RES	1	
80	100K	RES	1	
81	100K	RES	1	
82	100K	RES	1	
83	100K	RES	1	
84	100K	RES	1	
85	100K	RES	1	
86	100K	RES	1	
87	100K	RES	1	
88	100K	RES	1	
89	100K	RES	1	
90	100K	RES	1	
91	100K	RES	1	
92	100K	RES	1	
93	100K	RES	1	
94	100K	RES	1	
95	100K	RES	1	
96	100K	RES	1	
97	100K	RES	1	
98	100K	RES	1	
99	100K	RES	1	
100	100K	RES	1	

NOTA: I valori sono quelli di serie per il prodotto.
 Per maggiori informazioni visitate il sito www.sagem.it

CONTENTS	PAGE
Safety Instructions	2
Technical Specifications	3
Block Diagram	4
Pin Voltages of IC's	5
Oscillograms	8
Electrical and Service Adjustments	12
Part List	15
Circuit Diagrams	Attached

SAFETY INSTRUCTIONS

GENERAL GUIDELINES

1. It is advised to insert an isolation transformer in the AC supply before servicing a hot chassis.
2. Potentials as high as 33KV are present when this receiver is in operation. Operation of the receiver without the rear cover involves the danger of a shock hazard from the receiver power supply. Servicing should not be attempted by any one who is not competent with the precautions necessary when working on the high voltage equipment. Always discharge the anode of the tube.
3. When servicing observe the original lead dress in the high voltage circuits. If a short circuit is found, replace all the parts which have been overheated or damaged by the short circuit.
4. Always use the manufacturer's replacement safety components. The critical safety components marked with Δ on the schematics diagrams should not be replaced by other substitutes. Other substitute may create the electrical shock, fire or other hazards. Take attention to replace the spacers with the originals. Furthermore where a short circuit has occurred, replace those components that indicate evidence of overheating.
5. After servicing, see that all the protective devices such as insulation barriers, insulation papers, shields and isolation R-C combinations are correctly installed.
6. When the receiver is not being used for a long time of period of time, unplug the power cord from the AC outlet.
7. After servicing make the following leakage current checks to prevent the customer from being exposed to shock hazard.

LEAKAGE CURRENT COLD CHECK

1. Unplug the AC cord and connect a jumper between the two prongs of the plug.
2. Turn the receiver's power switch on.
3. Measure the resistance value with an ohmmeter, between the jumpered AC plug and each exposed metallic cabinet part on the receiver, such as screw heads, aerials,

connectors, control shafts etc. When the exposed metallic part a return path to the chassis the reading should be between 4Mohm and the 20Mohm. When the exposed metal does not have a return path to the chassis, the reading must be infinite.

LEAKAGE CURRENT HOT CHECK

1. Plug the AC cord directly in to the AC outlet. Do not use an isolation transformer for this check.
2. Connect a 2Kohm 10W resistor in series with an exposed metallic part on the receiver and an earth, such as a water pipe.
3. Use an AC voltmeter with high impedance to measure the potential across the resistor.
4. Check each exposed metallic part and check the voltage at the each point.
5. Reverse the AC plug at the outlet and repeat each of the above measurements.
6. The potential at the any point should not exceed 1.4 Vrms. In case a measurement is outside the limits specified, there is the possibility of a shock hazard, and the receiver should be repaired and rechecked before it is returned to the customer.

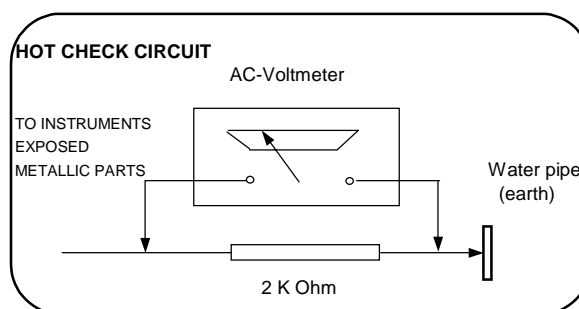

Figure 1

X-RAY RADIATION WARNING

The primary source of X-ray radiation in this receiver is the picture tube. The chassis is specially constructed to limit X-ray radiation. For continued X-ray radiation protection, replace the tube with the same type of the original one.

CAUTION

AFTER REMOVAL OF THE ANODE CAP, DISCHARGE THE ANODE OF THE PICTURE TUBE AND THE ANODE CAP TO THE METAL CHASSIS, CRT SHIELD, OR THE CARBON PAINTED ON THE CRT WITH A HIGH VOLTAGE PROBE AND MULTIMETER (SELECT VDC) AND THEN SHORT CIRCUIT DIRECTLY TO DISCHARGE COMPLETELY.

TECHNICAL SPECIFICATIONS

Power source:	220-240V AC, 50-60Hz	
Power consumption (max.):	115 W	20", 21" (110W for 21" PF)
Standby power consumption :	4 W	
Aerial impedance :	75Ohm, coaxial type	
Receiving system ¹:	PAL BG PAL SECAM BG PAL SECAM BG DK PAL SECAM BG LL' PAL I	
Receiving channels:	VHF BAND I	CH2-4
	VHF BAND III	CH5-12
	CABLE TV	S1-41
	UHF BAND	CH21-69
Audio outputs :	2 x 7W RMS at %10 THD	
High Voltage :	25 ± 0.5 KV	20", 21"
Focus voltage :	%25.6 ± %38 of EHT	
Grid 2 voltage :	0-1400 V	
Heater voltage :	6.2 ± 0.2 Vrms	
Video/Audio Terminals :	AV1 IN	Video : 1 Vpp,75 Ohm Audio : 0.5 Vrms, >10 Kohm RGB
	AV1OUT	Video : 1 Vpp, 75 Ohm Audio : 0.5 Vrms, <1 Kohm
	AV2 IN (optional)	Video : 1 Vpp,75 Ohm Audio : 0.5 Vrms, >10 Kohm
	AV2 OUT (optional)	Video : 1 Vpp, 75 Ohm Audio : 0.5 Vrms, <1 Kohm
	AV2 IN (RCA, optional)	Video : 1 Vpp, 75 Ohm Audio : 0.5 Vrms, >10 Kohm
Operating temperature :	0-45 Degrees	
Safety :	IEC 65 /BS P2N	
X-Ray radiation :	ACC. IEC 65/BS P2N	

¹ : TV set is produced to receive "one" of these colour and sound systems.

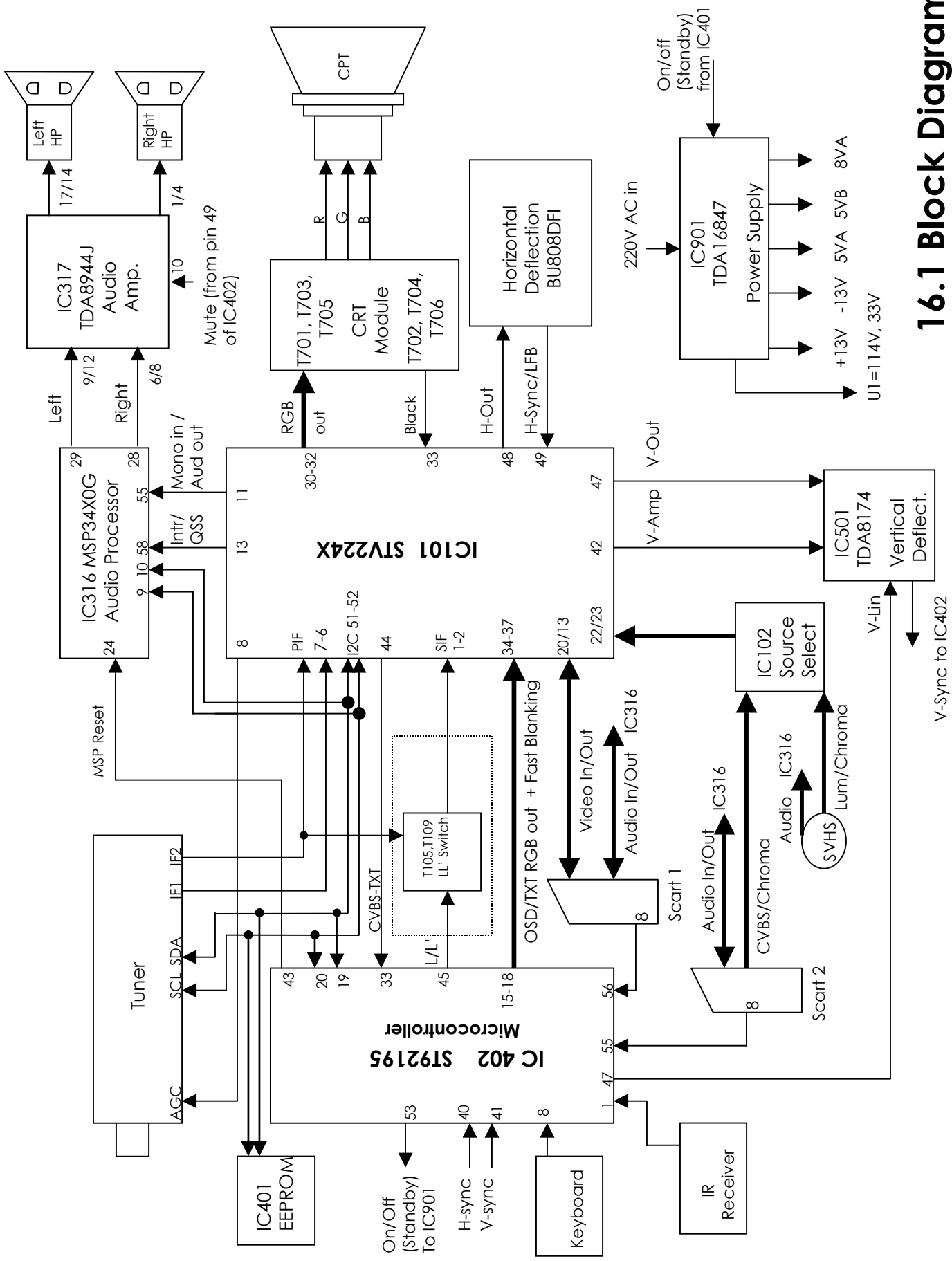

16.1 Block Diagram

PIN VOLTAGES OF IC'S

IC101 (STV2246) BUS CONTROLLED MULTISTANDARD ONE CHIP TV PROCESSOR					
Pin	Connection	V DC (*)	Pin	Connection	V DC (*)
1	Sound IF Input 1	1,0	29	Not connected	3,9
2	Sound IF Input 2	1,0	30	Blue Output	2,3
3	AGC SIF Capacitor	0,1	31	Green Output	2,2
4	IF Voltage Reference Filtering	3,2	32	Red Output	2,3
5	AGC PIF Capacitor	0,1	33	Cathode Current Measurement Input	4,2
6	Picture IF Input 1	2,5	34	OSD Blue Input	4,7
7	Picture IF Input 2	2,5	35	OSD Green Input	4,8
8	AGC Tuner Output	4,6	36	OSD Red Input	4,7
9	IF PLL Filter	1,2	37	OSD Fast Blanking	0,2
10	IF Ground	0,0	38	Cloche Filter Tuning Capacitor	0,1
11	AM/FM Mono Sound Output	4,2	39	3.5X MHz Crystal	0,4
12	5 V IF Supply	5,1	40	4.43 MHz Crystal	-
13	Internal CVBS Output	3,2	41	Chroma PLL Filter	-
14	External Audio Input	2,5	42	Vertical Amplitude DAC Output	4,0
15	LC Input 1	4,0	43	Chroma/Scanning Ground	0,0
16	LC Input 2	4,0	44	Second Video Switch Output	4,1
17	Video/Luma Supply Voltage (8 V)	8,1	45	Chroma/Scanning Power Supply (8V)	8,1
18	Internal Video Input	3,7	46	Beam Current Limiter Control Voltage and Safety Input (XRAY)	6,8
19	Video/Luma Ground	0,0	47	Vertical Output Pulse	4,0
20	External Video Input	3,2	48	Horizontal Output Pulse	1,4
21	Black Stretch Capacitor	2,8	49	Line Flyback Input and Super-sandcastle Output	0,7
22	Y/CVBSIN3 Y(SVHS) or CVBS3 External Input	3,2	50	Scanning PLL Filter	4,1
23	Chroma (SVHS) Input	1,8	51	SCL I2C Bus Clock Input	see osc.
24	Automatic RGB Peak Regulation	5,0	52	SDA I2C Bus Data Input	see osc.
25	External Blue Input	2,5	53	Digital Supply Voltage (5 V)	5,2
26	External Green Input	1,7	54	Digital Ground	0,0
27	External Red Input	2,5	55	Main Audio Output	4,0
28	External Fast Blanking Input	0,0	56	FM Demodulation Capacitor	1,5

IC316 (MSP 34XXG)- MULTI STANDARD SOUND PROCESSOR

Pin	Connection	V DC	Pin	Connection	V DC
1	Not connected	2,3	33	Scart 2 sound output (R)	3.7
2	Gnd	0,0	34	Scart 2 sound output (L)	3.7
3	Gnd	0,0	35	Reference analog ground	0,0
4	Digital control input/output	0,0	36	Scart 1 sound output (R)	3.7
5	Digital control input/output	0,0	37	Scart 1 sound output (L)	3.7
6	Gnd	0,0	38	Volume capacitor Headphone	7,1
7	Standby (in normal operation it must be high)	4.9	39	Analog Supply High Voltage (8V)	8,0
8	Not connected	4.9	40	Volume capacitor Speaker	7,1
9	SCL	see osc.	41	Ground for Analog Power Supply High Voltage	0,0
10	SDA	see osc.	42	Internal Analog Reference Voltage	3.7
11	Not connected	0,5	43	Scart 4 input (L)	3.7
12	Not connected	0,5	44	Scart 4 input (R)	3.7
13	Not connected	0,5	45	Analog Shield Ground	0,0
14	Not connected	0,5	46	CINCH - sound input (L)	3.7
15	Not connected	0,5	47	CINCH - sound input (R)	3.7
16	Not connected	0,5	48	Analog Shield Ground	0,0
17	ADR Bus Clock Output	0,5	49	Scart 2 sound input (L)	3.7
18	Digital Circuitry Supply Voltage	4.9	50	Scart 2 sound input (R)	3.7
19	Digital Circuitry Supply Ground	0,0	51	Analog Shield Ground	0,0
20	Not connected	0,5	52	Scart sound 1 input (R)	3.7
21	Not connected (Ground)	0,0	53	Scart 1 sound input (L)	3.7
22	Not connected (Ground)	0,0	54	A/D converter ref. Voltage	2.5
23	Not connected (Ground)	0,0	55	Mono sound input	3.7
24	MSP RESET input	5,1	56	Ground for Analog Power Supply Voltage	0,0
25	Headphone sound output (R)	0,1	57	Analog Power Supply Voltage (5V)	4.9
26	Headphone sound output (L)	0,1	58	IF input 1	1.5
27	Reference analog ground	0,0	59	IF Common reference for IF IN1/IN2	1.5
28	Speaker output (R)	0.1-2.1	60	IF input 2	0,0
29	Speaker output (L)	0.1-2.1	61	Factory test mode enable (ground)	0,0
30	Not connected	0.1-2.1	62	Crystal oss. input	2.3
31	Not connected	0.1-2.1	63	Crystal oss. output	2.3
32	Not connected	0.1-2.1	64	Not connected (Ground)	0,0

IC317 (TDA 8944J) Audio Output IC

Pin	Connection	V DC	Pin	Connection	V DC
1	negative loudspeaker terminal 1	6,1	10	mode select.input (standby,mute,operating)	0,0
2	ground channel 1	0,0	11	half supply voltage decoupling (ripple rejection)	6,2
3	supply voltage channel 1	12,4	12	positive input 2	6,2
4	positive loudspeaker terminal 1	6,1	13	DC gain control	0,0
5	not connected	0,0	14	negative loudspeaker terminal 2	6,1
6	positive input 1	6,2	15	ground channel 2	0,0
7	signal ground	0,0	16	supply voltage channel 2	12,4
8	negative input 1	6,2	17	positive loudspeaker terminal 2	6,2
9	negative input 2	6,2			

IC402 (ST92195B)
MICRO CONTROLLER WITH OSD AND TELETEXT

Pin	Connection	V DC (*)	Pin	Connection	V DC (*)
1	Infra red input	4,9	29	Analog pin for TXT	2,0
2	Reset	4,3	30	Not connected	1,0
3	Not connected	0,0	31	Analog power supply for PLL (5V)	4,9
4	Not connected	0,0	32	Not connected	4,8
5	Not connected	0,0	33	CVBS input for TXT	0,5
6	Not connected	0,0	34	CVBS input for TXT	1,7
7	Not connected	0,0	35	Analog circuit ground	0,0
8	Local keyboard input	4,9	36	Digital circuit ground	0,0
9	Not connected	0,0	37	Analog pin for OSD	0,0
10	Not connected	0,0	38	Analog pin for OSD	1,9
11	Not connected	0,0	39	Analog power supply (5V)	4,9
12	Not connected	0,0	40	Horizontal sync for OSD	0,7
13	Used for factory mode	4,9	41	Vertical sync for OSD	0,2
14	Not connected	0,0	42	Not connected	0,2
15	Blue output for OSD and TXT	0,7	43	Not connected	5,2
16	Green output for OSD and TXT	0,7	44	Not connected	0,0
17	Red output for OSD and TXT	0,7	45	LL' select output	4,8
18	Fast Blanking for OSD and TXT	0,0	46	Not connected	0,1
19	SDA I2C Bus Data Input	see osc.	47	Vertical linearity output	0,8
20	SCL I2C Bus Clock Input	see osc.	48	Standby/Mute	5.0 (0.2)
21	Supply Voltage (5V)	4,9	49	Standby/Mute	5.0 (0.2)
22	Not connected	0,9	50	Oscillator out	2,3
23	Ground	0,0	51	Oscillator in	2,4
24	Ground	0,0	52	Not connected	0,1
25	Analog Vdd of PLL	-	53	On/Off (standby activate/deactivate)	0.2 (2.8)
26	Testpins: must be tied to pin 25	-	54	Not connected	0,1
27	Analog pin for OSD	1,7	55	Not connected	0,0
28	Not connected	4,8	56	Status signal input of Scart pin 8	0,0

IC501 (TDA8174) Vertical Deflection Output IC

Pin	Connection	V DC	Pin	Connection	V DC
1	Power output	13,4	7	Ramp generator	5,5
2	Output stage Vs	27,6	8	Buffer output	6,4
3	Trigger input	4,0	9	Inverting input	4,5
4	Height adjustment	6,8	10	Vs	27,6
5	Not connected	4,5	11	Flyback generator	1,3
6	Ground	0,0			

IC901 (TDA16847) Power Supply IC

Pin	Connection	V DC (*)	Pin	Connection	V DC (*)
1	Off time circuit (for standby frequency)	2.4 (0.4)	8	Power measurement output	1.5 (2.4)
2	Primary Current Simulation and Startup	1.9 (10.9)	9	Reference Ref. Voltage (5V)	4.9 (1.1)
3	Regulation and Zero Crossing Input	2.6 (0.3)	10	Fault Comparator 1 (not used)	0,0
4	Soft-Start and Regulation Capacitor	3.7 (0.3)	11	Primary Voltage Check	1.7 (2.5)
5	Opto Coupler Input (not connected)	4.9 (0.8)	12	Ground	0,0
6	Fault Comparator 2 (not used)	0,0	13	Output	4.0 (0.4)
7	Synchronization Input (for fixed freq.)	4.9 (1.1)	14	Supply Voltage	13.6 (11.7)

(*) Standby measurement values are given in parenthesis

WAVEFORMS OF SOME IC PINS

Note: TV is connected to a pattern generator (Colour bar, sound 1 kHz).

IC101 (STV224X)

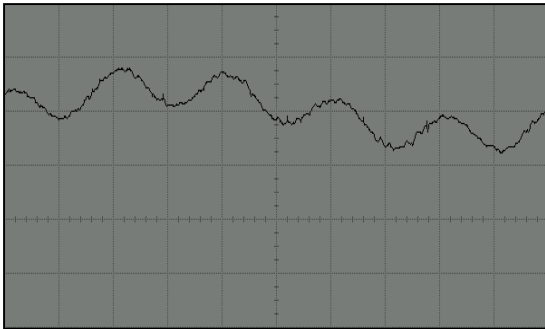

Pin 11

1V/div, 100 usn/div, Vpp=1.6 V

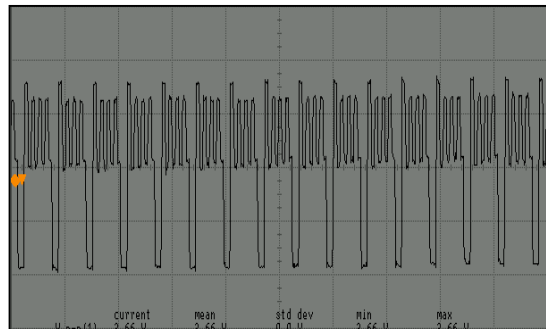

Pin 30

1V/div, 100 usn/div, Vpp=3.7 V, 15625 Hz

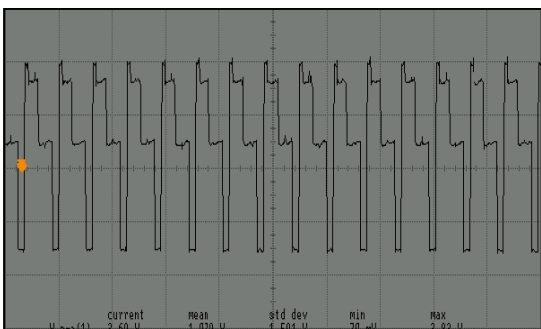

Pin 31

1V/div, 100 usn/div, Vpp=3.7 V, 15625 Hz

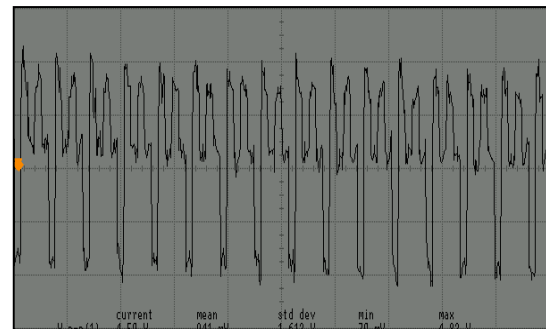

Pin 32

1V/div, 100 usn/div, Vpp=4.5 V, 15625 Hz

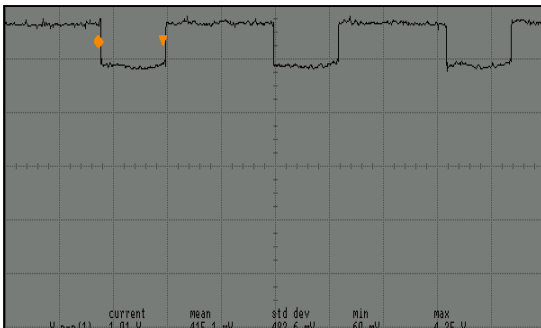

Pin 34 (OSD Off)

1V/div, 20 usn/div, Vpp=1 V, 15625 Hz

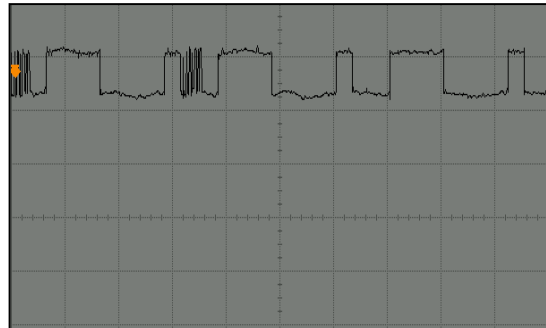

Pin 34 (OSD On)

1V/div, 20 usn/div, Vpp=1 V, 15625 Hz

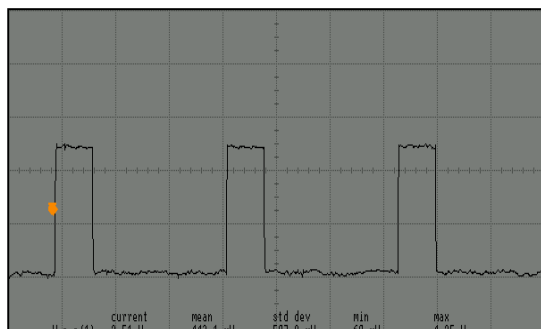

Pin 37 (OSD On)

1V/div, 20 usn/div, Vpp=2.51 V, 15625 Hz

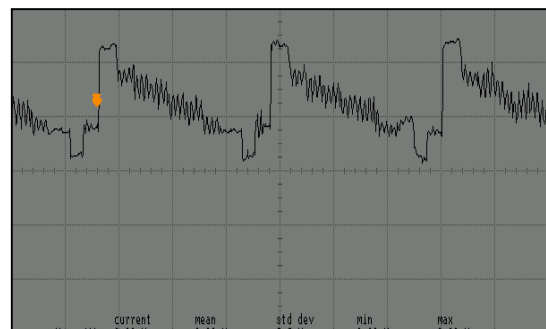

Pin 44

1V/div, 20 usn/div, Vpp=2.3 V, 15625 Hz

IC101 (STV224X)

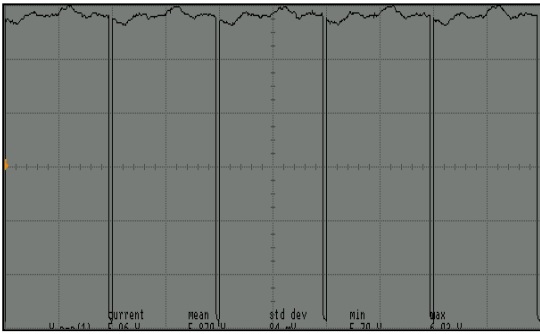

Pin 47

1V/div, 10 msn/div, Vpp=6.0 V, 50 Hz

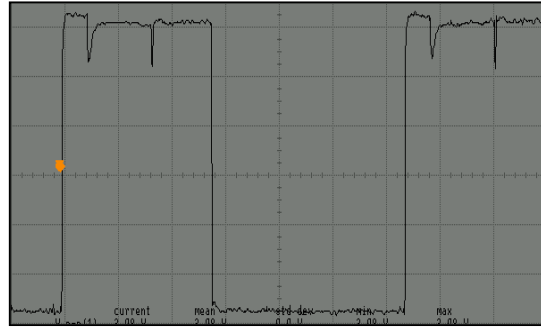

Pin 48

1V/div, 10 usn/div, Vpp=3.1 V, 15625 Hz

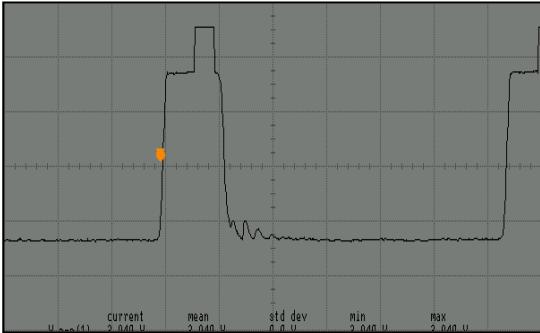

Pin 49

1V/div, 10 usn/div, Vpp=3.9 V, 15625 Hz

IC316 (MSP34X0G)

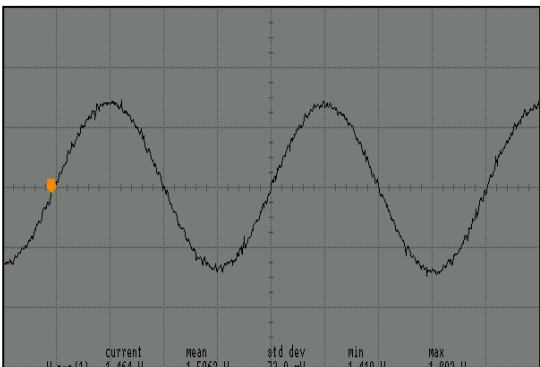

Pin 28

500mV/div, 50 usn/div, Vpp=1.5 V, 5kHz

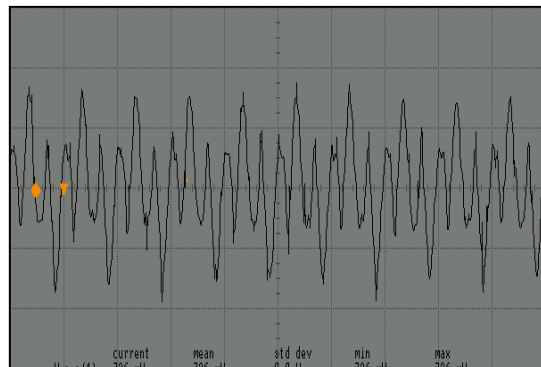

Pin 55

200mV/div, 20 msn/div, Vpp=0.7 V

IC402 (ST92195B)

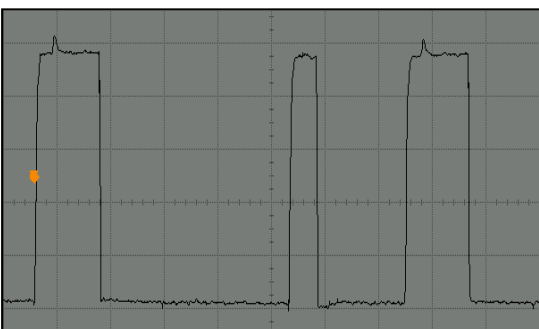

Pin 19

1V/div, 20 usn/div, Vpp=5.2 V

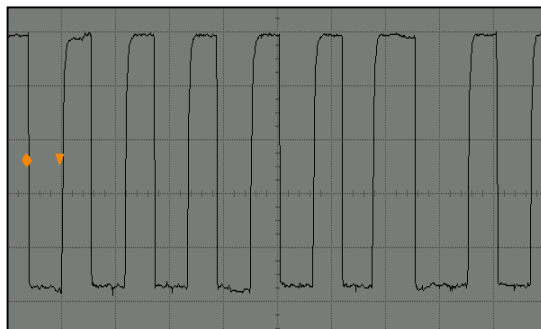

Pin 20

1V/div, 20 usn/div, Vpp=4.9 V, 15625 Hz

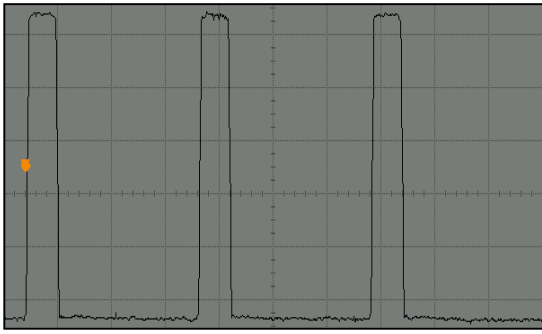

Pin 40

1V/div, 20 usn/div, Vpp=5.9 V, 15625 Hz

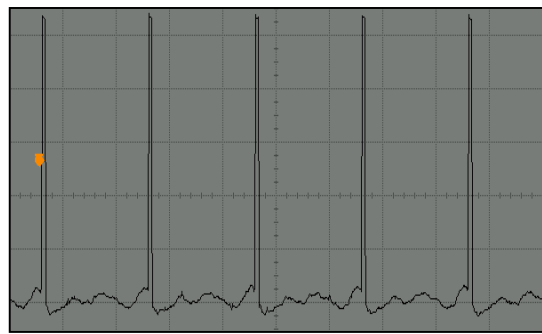

Pin 41

1V/div, 10 msn/div, Vpp=5.7 V, 50 Hz

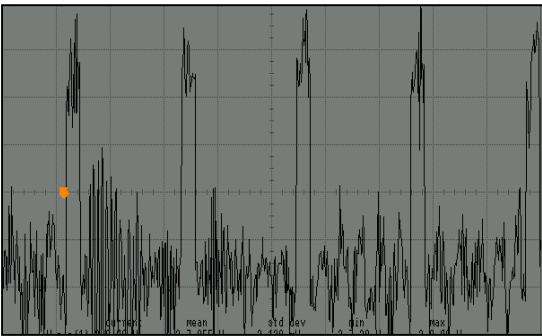

Pin 47

1V/div, 20 usn/div, Vpp=5.9 V, 15625 Hz

IC501 (TDA8174)

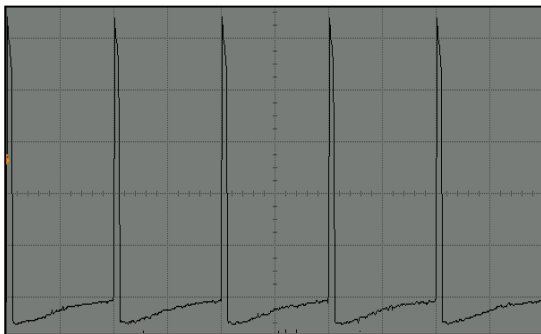

Pin 2

5V/div, 10 msn/div, Vpp=26.7 V, 50 Hz

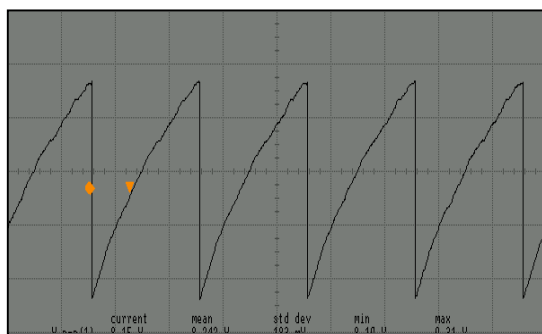

Pin 7

2V/div, 10 msn/div, Vpp=8.1 V, 50 Hz

T551

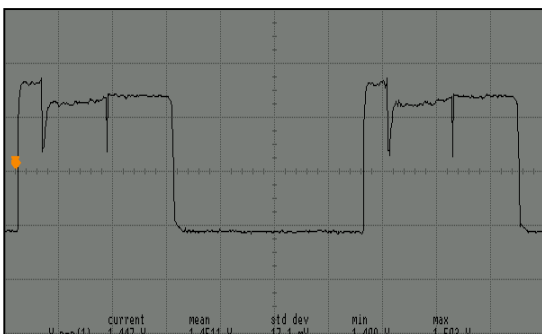

Base

500mV/div, 10 usn/div, Vpp=1.5V, 15625 Hz

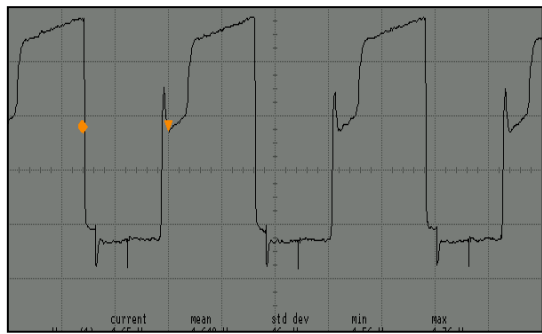

Collector

1 V/div, 20 usn/div, Vpp=4.7V, 15625 Hz

T552

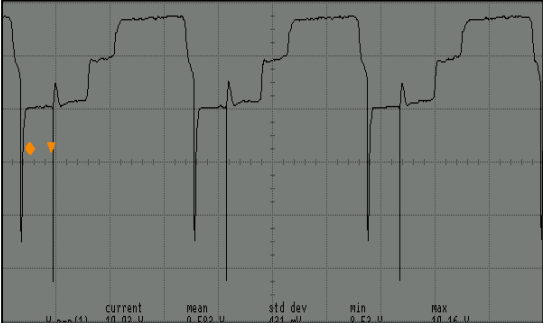

Base

2 V/div, 20 usn/div, Vpp=10V, 15625 Hz

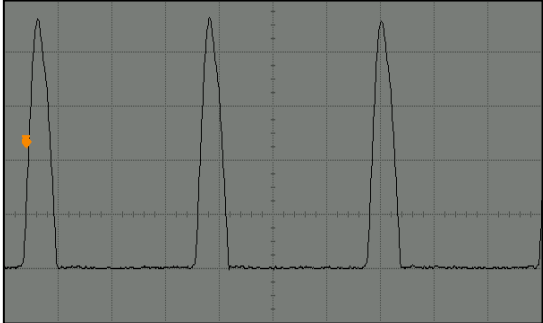

Collector

200 V/div, 20 usn/div, Vpp=932V, 15625 Hz

1. ELECTRICAL ADJUSTMENTS

1.1 Supply Voltage Adjustment

Connect a digital voltmeter to the cathode of diode D950 at the AV mode of the TV and set the screen voltage to the minimum with the screen potentiometer. Adjust the main supply voltage (B+) with P901 potentiometer to the following value (after supply adjustment, readjust Screen and focus voltage).

20" : 119 VDC (for A48ECR43X51)
21" : 114 VDC (for A51EER33X41)

2. SERVICE ADJUSTMENTS

You need the special service remote control to enter and exit the service menu of the TV (you can order it from the manufacturer). All buttons of the Service RC are same with the user remote control, only service menu In / Out is added to it (please see the picture below).

Navigation

Service In/Out : Enters to / exits from the Service Menu

P+ / P- : Moves upward / downward inside the menu

V+ / V- : Changes the values or options

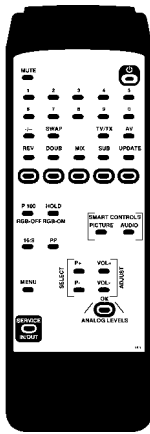

2.1 IF Adjustments

2.1.1 PAL SECAM BG/DK/I

- Supply a 471.25 MHz BG system colour bar RF signal to the set by a pattern generator.
- Find this signal in "setup" menu (C21).
- In order to deactivate AFT loop, shift value of "fine tuning" from central point by one unit and then shiftback to the central point again (2 small vertical lines are seen in the scale on central point).
- Store the channel by selecting "Store" and pressing "OK" button.
- Switch on the Service Menu with the Service RC.
- Check that value of "VCO C" is "07".
- Adjust the coil LC100 until the colour of ":" sign turns red ("<" and ">" are white).
- Check that value of "VCO F" is "63".
- Adjust the coil LC100 until the colour of ":" sign turns red ("<" and ">" are white).
- Exit from the service menu with the Service RC.

2.1.2 SECAM L/L' (if available)

- Supply a 55.75 MHz, L' system colour bar RF signal to the set by a pattern generator.
- Find this signal in "setup" menu (C02).
- In order to deactivate AFT loop, shift value of "fine tuning" from central point by one unit and then shiftback to the central point again (2 small vertical lines are seen in the scale on central point).
- Store the channel by selecting "Store" and pressing "OK" button.
- Switch on the Service Menu with the Service RC.

- Change the value of "VCO C L", until the colour of ":" sign turns red ("<" and ">" are white).
- Change the value of "VCO F L", until the colour of ":" sign turns red ("<" and ">" are white).
- Exit from the service menu with the Service RC.

2.2 AGC Adjustment

- Apply a signal with amplitude 70 ± 1 dBuV to the antenna input of TV with a pattern generator (switch sound carrier to Off and switch "Video Ext" to On).
- Switch on the Service Menu with the Service RC and find the "AGC1" with P+ / P- buttons.
- Measure the amplitude of 38.9 MHz sinusoidal signal on pin 11 (IF2) of Tuner with an oscilloscope.
- Adjust "AGC1" to get 540 ± 20 mVpp.
- Add 5 to "AGC1" value and change "AGC2" to this value.
- Exit from the service menu with the Service RC.

2.3 Screen Adjustment

- Switch to AV mode.
- Adjust the Screen potentiometre until the voltage across the pin of R727 (that is connected CRT cathode) and ground is 170 ± 3 VDC (For 20" Ekranas, 21" GS7 or 21" Pure Flat CPT's, adjustment value is 160 ± 3 VDC).

2.4 White Balance Adjustment

- Apply a white pattern with a pattern generator to the antenna input.
- Enter the Service Menu with the Service RC and select "BLUE" option with P+ / P- buttons and change its value to "31" with V+ / V- button.
- Adjust "RED" and "GRN" for white balance.
- Adjust "RED BIAS" and "GRN BIAS" for red and green cut off (There is no blue cut off adjustment).
- If white balance can not be adjusted properly change "BLUE" value.
- Exit from Service menu.

2.5 Geometry Adjustments

- Apply the cross hatch pattern with a pattern generator to the antenna input.
- Enter Service Menu with Service RC.
- Adjust Vertical Amplitude with "VAMP1 4/3 50Hz" option.
- Set "VAMP2 16/9 50Hz", "VAMP3 4/3 60Hz" and "VAMP4 16/9 60Hz" values according to formulas in section 2.7 Factory Settings for Service Mode.
- Adjust vertical position with "VSHT", vertical linearity with "VLIN", horizontal position with "HSHT" and vertical position of Teletext with "TXT VPOS".
- Exit from the Service Menu.

Note that: There is no horizontal width adjustment in this chassis. It can be adjusted by changing power supply voltage in the interval of -1 and +1 V.

2.6 Feature Options

TUNER	: Panasonic 1 (ENV57D44G3), Panasonic2 (ENV57D60G3), Phillips, Sharp, Temic
SSTD	: BG, I, BG+DK, BG + L
NICAM	: NICAM On (available), NICAM Off
VIR.DOLBY	: Yes (available), No
XTAL	: 1 (4,43), 2 (4,43-3,58) (NTSC Playback available)
APPL	: INTERCAR (Intercarrier, all versions except Secam LL'), QSS (Secam LL')
OSD CONTR	: On (OSD level control is On), Off
BLUE SCRN	: On (Blue background is On), Off
APR	: On (Max. RGB level control is On), Off
COFF BLNK	: On (Auto cut off stabilization control is On), Off
AM SND	: MSP34XX, STV224X
HEAD	: Yes (Headphone available), No
FASTTEXT	: Yes (available), No

NUM.OF AV : Please see Table 1
 AV2 : Please see Table 1
 STD-BY : ON (Default, Automatic switch off is active), OFF (can be used during repair)
 KEYBOARD : 3 (3-button version), 4 (4-button version)

	NUM.OF AV	AV2
1 Scart + Headphone	01	NO
1 Scart + Front AV + Headphone	02	CINCH Front-AV
1 Scart + Front AV + SVHS + Headphone	03	CINCH Front-AV
1 Scart (No Headphone)	01	NO
1 Scart + Front AV (No Headphone)	02	SCART 2
1 Scart + Front AV + SVHS (No Headphone)	03	SCART 2
2 Scarts * (SVHS not available on Scart 2)	02	SCART 2
2 Scarts	03	SCART 2
2 Scarts + Front AV	04	SCART 2
2 Scarts + Front AV + SVHS	05	SCART 2

Note : Except the version signed with "*", all 2 Scarts versions have SVHS feature on Scart 2.

Table 1

2.7 Factory Settings for Service Mode

Values given in Table 2 are typical values and can vary according to the CRT type.

		20"	21"	21" Pure Flat
AGC1	Automatic Gain Control 1	32	32	32
AGC2	Automatic Gain Control 2	AGC1 + 5	AGC1 + 5	AGC1 + 5
STD BY	Standby	ON	ON	ON
SCRN	Screen (used for screen adj.)	OFF	OFF	OFF
VCO C	VOC Coarse (BG/I/DK)	07	07	07
VCO F	VCO Fine (BG/I/DK)	63	63	63
VCO C L	VOC Coarse (LL')	07	07	07
VCO F L	VCO Fine (LL')	63	63	63
RED	Red level	14	10	40
GRN	Green level	00	00	33
BLUE	Blue level	31	31	31
RED BIAS	Black level offset red	18	30	34
GRN BIAS	Black level offset green	23	28	28
VAMP1 4/3 50HZ	Vertical amplitude 4/3 PAL/SEC	33	32	23
VAMP2 16/9 50HZ	Vertical amplitude 16/9 PAL/SEC	VAMP1 + 20	VAMP1 + 20	VAMP1 + 18
VAMP3 4/3 60HZ	Vertical amplitude 4/3 NTSC	VAMP1 - 18	VAMP1 - 18	VAMP1 - 18
VAMP4 16/9 60HZ	Vertical amplitude 16/9 NTSC	VAMP1 + 2	VAMP1 + 2	VAMP1 + 4
TXT VPOS	Teletext Vertical Position	15	15	15
VSHT	Vertical shift	08	11	06
VLIN	Vertical linearity	31	31	51
HSHT	Horizontal shift	35	33	49

Table 2

2.8 Exit from Service Menu

During exit from service menu, the software version and feature options (hexadecimal number) are shown on the screen.

For example: SB5641-Xyy T01 CEECBE (X shows OSD Language group, yy shows software version).

A group languages = English, German, French, Italian, Spanish, Portugal, Greek, Turkish, Dutch, Swiss, Danish, Norwegian, Finnish, Hungarian, Hebrew

B group languages = English, French, Russian, Bulgarian, Serbian, Polish, Slovenian, Romanian, Macedonian, Croatian, Czech, Slovak, Albanian, Arabian, Persian

SPARE PARTS LIST

PART NO	DESCRIPTION	NOTES	POSITION NUMBERS
250111	EC 1UF 16V 11*5 R:5		C101 C125 C136 C138 C141
293108	CC-CHIP 10NF K 50V /0805 X7		C102 C104 C140
250111	C-ELA 1UF 16V 11*5 R:5		C103
251107	EC 10UF M 16V 11*5 R:5		C105 C111 C134 C142
293230	CC-CHIP 22NF K 50V /0805 X7		C108 C179
294331	CC-CHIP 330NF K 16V /0805 X		C109
291822	CC-CHIP 820PF J 50V /0805 N		C112 C131
251478	EC 47UF 16V 11*5 R:5		C113 C145
294111	CC-CHIP 100NF K 25V /0805 X		C119 C120 C121 C122
252112	EC 100UF 16V 11*6 R:5		C127
292476	CC-CHIP 4.7NF K 50V /0805 X		C128 C129 C188
250227	EC 2.2UF 16V 11*5 R:5		C130 C173 C174
252229	EC 220UF 16V 11*8 R:5		C135
250111	C-ELA 1UF 16V 11*5 R:5	LL' SYSTEM	C143
251107	EC 10UF M 16V 11*5 R:5		C144 C170 C189
291225	CC-CHIP 220PF K 50V /0805 X		C148 C154 C156
291225	CC-CHIP 220PF K 50V /0805 X		C149 C162 C164
292110	CC-CHIP 1NF K 50V /0805 X7R		C150 C151 C152 C153 C169
291477	CC-CHIP 470PF J 50V /0805 N		C155 C157 C163 C165
292110	CC-CHIP 1NF K 50V /0805 X7R		C158 C159 C160 C161
293230	CC-CHIP 22NF K 50V /0805 X7		C166 C171 C172
294111	CC-CHIP 100NF K 25V /0805 X		C167 C168
291103	CC-CHIP 100PF J 50V /0805 N		C175 C176 C177
291560	CC-CHIP 560PF J 50V /0805 N		C178
290274	CC-CHIP 27PF J 50V NPO 0805		C180
290684	CC-CHIP 68PF J 50V /0805 NPO	LL' SYSTEM	C184
294228	CC-CHIP 220NF Z 50V /0805 Y5U	LL' SYSTEM	C185 C186
202105	C-CE 1NF K 1KV Y5P R:5	LL' SYSTEM	C187
293108	CC-CHIP 10NF K 50V /0805 X7		C191 C192 C194 C195
290684	CC-CHIP 68PF J 50V /0805 NP		C200
252112	EC 100UF 16V 11*6 R:5		C315 C338 C339
293474	CC-CHIP 47NF K 50V /0805 X7		C316
274332	C-PEM 330NF K 63V R:5		C340 C341
292223	CC-CHIP 2.2NF K 50V /0805 X		C342 C343
291223	CC-CHIP 220PF J 50V /0805 N		C346
294109	CC-CHIP 100NF K 50V /0805 X		C347 C348 C349 C350 C351
299152	CC-CHIP 1.5PF C 25V/0805		C352 C353
293108	CC-CHIP 10NF K 50V /0805 X7		C354 C355 C356
250470	EC 4.7UF 16V 11*5 R:5		C358 C359 C360 C361
294331	CC-CHIP 330NF K 16V /0805 X	CINCH	C362 C363
251478	EC 47UF 16V 11*5 R:5		C370 C371
293332	CC-CHIP 33NF K 50V /0805 X7R		C373
292110	CC-CHIP 1NF K 50V /0805 X7R		C374
294231	CC-CHIP 220NF K 16V /0805 X7R		C375
293474	CC-CHIP 47NF K 50V /0805 X7R		C376 C377 C378
292151	CC-CHIP 1.5NF K 50V /0805 X7R		C379 C380
274104	C-PEM 100NF K 63V R:5		C382 C383
253106	EC 1000UF 25V 20*13 R:5		C384
251107	EC 10UF M 16V 11*5 R:5		C386
293474	CC-CHIP 47NF K 50V /0805 X7		C401 C402 C404 C407 C420
203106	CC 10NF K 50V R:5		C405
292476	CC-CHIP 4.7NF K 50V /0805 X		C408 C409
250227	EC 2.2UF 16V 11*5 R:5		C410
290390	CC-CHIP 39PF K 50V /0805 NP	Mask type Microprocessor	C412 C413
290156	CC-CHIP 15PF K 50V /0805 NP	OTP type Microprocessor	C412 C413
290821	CC-CHIP 82PF J 50V /0805 N7		C414
292223	CC-CHIP 2.2NF K 50V /0805 X		C415
251107	EC 10UF M 16V 11*5 R:5		C416 C418 C436
290222	CC-CHIP 22PF J 50V /0805 NP		C419 C424 C431 C432
294476	CC-CHIP 470NF K 16V /0805 X		C421

SPARE PARTS LIST

179001	RC-CHIP 0R /0805 2*1.25	BG/DK SYSTEM	C423 L108 R336 R337 R338
291560	CC-CHIP 560PF J 50V /0805 N		C429 C437 C438
252229	EC 220UF 16V 11*8 R:5		C430
251478	EC 47UF 16V 11*5 R:5		C433 C439
293108	CC-CHIP 10NF K 50V /0805 X7		C435
274227	C-PEM 220NF J 50V R:5		C501
253101	EC 1000UF 35V 25*13 R:5		C503
252476	EC 470UF 25V 11*10 R:5	21"	C504
250111	EC 1UF 16V 11*5 R:5		C505 C511 C512
293152	CC-CHIP 15NF K 50V /0805 X7		C508
273333	C-PEM 33NF K 100V R:5		C508A
291477	CC-CHIP 470PF J 50V /0805 N		C509
252105	EC 100UF 50V 12*8 R:5		C510
250100	EC 1UF 160V 11*6.3 R:5		C553
271390	C-PPM 390NF J 250V R:15		C554
272820	C-PPM 8.2NF %3.5 1.5/1.6KV	21"	C555
272912	C-PPM 9.1NF %3.5 1.5/1.6KV	20"	C555
274330	C-PEM 330NF J 250V R:15		C556
251109	EC 10UF 250V 16*10 R:5		C560
202105	CC 1NF K 1KV Y5P R:5		C561
274107	C-PEM 100NF J 100V R:5		C563
252229	EC 220UF 16V 11*8 R:5	21"	C564
252482	EC 470UF 16V 12.5*10 R:5	20"	C564
271331	C-PPM 330PF J 1500V/1600V R		C565
251478	EC 47UF 16V 11*5 R:5		C571
250228	C-ELA 2.2UF 250V 11*8 R:5		C702
201476	C-CE 470PF K 1KV R:5		C705 C708 C711
274224	C-PEM 220NF K 275V-AC R22.	⚠	C901
274103	C-PEM 100NF K 275V-AC R:15	⚠	C902
202105	CC 1NF K 1KV Y5P R:5		C903 C904 C917 C918
203330	C-PPM 33NF J 630V R:15		C906
201471	CC 470PF 2KV		C907
293108	CC-CHIP 10NF K 50V /0805 X7		C909
293474	CC-CHIP 47NF K 50V /0805 X7		C910 C955 C958 C967
291123	CC-CHIP 120PF K 50V /0805 X		C911
292223	CC-CHIP 2.2NF K 50V /0805 X		C913 C914
274105	C-PEM 100NF J 250V R:10	⚠	C915
274332	C-PEM 330NF K 63V R:5		C919
202220	CC 2.2NF M 250VAC Y5U R:10	⚠	C920
202106	CC 1NF K 50V Y5P R:5	CINCH	C920 C921
202102	C-CEA 1NF K 50V R:10	CINCH	C922 C923
290561	CC-CHIP 56PF J 50V NPO 0805	CINCH	C923
273471	C-PEM 47NF K 63V R:5	HEADPHONE	C940 C941
201226	CC 220PF K 2KV Y5P R:5		C950
250470	EC 4.7UF 16V 11*5 R:5		C956
251225	EC 22UF 16V 11*5 R:5		C965
291101	CC-CHIP 100PF J 50V /1206 N		C981 C982
303993	LED LTL4221N D:3 R/D RED		D01
303991	LED IR SIR563SB3F 23/940		D02
302296	DIODE 1N4148 26MM		D103
302289	DIODE 1N4148 52MM		D103
303195	DIODE 4148 MELF		D107
303223	DIODE-CHIP BA682 SOD80	LL' SYSTEM	D180 D181
303988	LED LTL 4224 RED (SHORT LEG	21"	D418
303850	LED LTL 4263 RED L=25.4	20"	D418
303308	DIODE RF2007		D502
302296	DIODE 1N4148 26MM		D503 D559
300305	DIODE BA157		D552 D556
303217	DIODE RGP10J		D553 D560
303195	DIODE 4148 MELF		D557

SPARE PARTS LIST

302289	DIODE 1N4148 52MM		D558
302948	DIODE 1N4007		D701
302289	DIODE 1N4148 52MM		D702 D703 D704
303308	DIODE RF2007		D901 D902 D903 D904
303217	DIODE RGP10J		D905
302289	DIODE 1N4148 52MM		D906 D907 D908 D909
303217	DIODE RGP10J		D950
303281	DIODE RGP50D		D951
056721	SER.FILTER TPS5.5MWA	BG SYSTEM	F101
056762	SER.FILTER TPT02B	BG/DK SYSTEM	F101
056745	SER.FILTRE TPS6.0MB	I SYSTEM	F101
056731	SER.FILTRE TPSRD5M50W00-A0	LL' SYSTEM	F101
056640-01	SER.FILTRE MKT40.4MA110P-TF01 MURATA	LL' SYSTEM	F102
056641	SER.FILTRE MKT40.9MA110P MURATA	I SYSTEM	F401
452382	IC-CHIP S3C1840DA9/SMB1		IC01
452842-01	IC STV2246C	PAL BG, I SYSTEMS	IC101
452836-01	IC STV2248C	PAL + SECAM LL' SYSTEM	IC101
452990	IC STV2249C	PAL/SEC BG/DK SYSTEM	IC101
452985	IC-CHIP MC14053BD SOIC16	TWO SCARTS	IC102
452374	IC L78L05 ACZ TR		IC315 IC953
452575-02	IC MSP3400G PP B8 V3	NON NICAM	IC316
452800	IC MSP3410G PSDIP64 AUDIO P	NICAM	IC316
452700	IC TDA 8944J		IC317
452844	IC-CHIP ST24C08 (EEPROM) 5V		IC401
MB5641-A11	IC ST92195C7 / 64K A-OSD MASK (EMJ)		IC402
MB5641-B11	IC ST92195C7 / 64K B-OSD MASK		IC402
452648	IC TDA8174AW		IC501
452986	IC TDA16847		IC901
451518	IC KA317TU T0220CASE		IC951
452374	IC L78L05 ACZ TR		IC953
053711	COIL 10UH K (TAIYO) LAL03		L101 L102 L315 L316
053805	COIL-CHIP 1UH K /0805		L103 L106
053740	COIL 1UH K LAL03		L104
053750	COIL 5.6UH K	DK SYSTEM	L105
053806	COIL-CHIP 8.2UH K /0805	BG SYSTEM	L107
179001	RC-CHIP OR /0805 2*1.25	LL' SYSTEM	L107
053816	COIL 18UH K /3.4 26MM		L401 L402
053726	COIL-CHIP 22UH %20/0805		L403
053798	COIL-CHIP 18UH K /0805		L404
053715	COIL 6.8UH K R12.5	⚠	L502
051585	COIL H-LIN 70UH		L551
051815	LINE FILTER 2 X 18 MH MIN.TYPE	⚠	L901
053739	COIL CHOKE 50UH		L950
053506-01	COIL DEMOD 38.9 HEX		LC100
055597	FERRITE BEAD 12*8		
056210	CER.RESONATOR GSB455E		Q01
132500	R-VAR 5K (V) 5*3		P901
056023	CRYSTAL 4.433619MHZ		Q101
056660	CRYSTAL 3.579545 90OHM		Q102
056952	CRYSTAL 18.432MHZ +-30PPM		Q315
056013	CRYSTAL 4 MHZ		Q401
179002	RC-CHIP OR /1206		R01
173273	CFR-CHIP 27K J 1/10W /0805		R101 R427
171150	RC-CHIP 150R J 1/10W /0805		R102 R124 R333 R334
171221	RC-CHIP 220R J 1/10W /0805		R104 R129 R441 R442
172101	RC-CHIP 1K J 1/10W /0805		R105 R112 R117 R120 R144

SPARE PARTS LIST

170472	RC-CHIP 47R J 1/10W /0805		R107 R106 R108 R113
101470	CFR 470R J 1/4W /6 52MM		R109 R110 R111
171471	RC-CHIP 470R J 1/10W /0805		R116
171102	RC-CHIP 100R J 1/10W /0805		R118 R119 R160
102141	CFR 1K J 1/4W /6 26MM		R121
172823	RC-CHIP 8.2K J 1/10W /0805		R122
172561	RC-CHIP 5.6K J 1/10W /0805		R123 R415 R416
171182	RC-CHIP 180R J 1/10W /0805		R125 R126
172101	RC-CHIP 1K J 1/10W /0805		R127 R172 R173
173101	RC-CHIP 10K J 1/10W /0805		R128
173562	RC-CHIP 56K J 1/10W /0805		R130
174331	RC-CHIP 330K J 1/10W /0805		R131 R188
172225	RC-CHIP 2.2K J 1/10W /0805		R132
171270	RC-CHIP 270R J 1/10W /0805		R135 R136 R137
173479	RC-CHIP 47K J 1/10W /0805		R138
172335	RC-CHIP 3.3K J 1/10W /0805		R139
171221	RC-CHIP 220R J 1/10W /0805	LL' SYSTEM	R142
170750	RC-CHIP 75R J 1/10W /0805		R152 R154 R163 R164 R166
170683	RC-CHIP 68R J 1/10W /0805		R157
170750	RC-CHIP 75R J 1/10W /0805		R158 R174
171332	RC-CHIP 330R J 1/10W /0805		R159 R161 R168 R208
171102	RC-CHIP 100R J 1/10W /0805		R160 R162 R182 R183 R184 R189
172101	RC-CHIP 1K J 1/10W /0805		R165 R167
171102	RC-CHIP 100R J 1/10W /0805		R169 R171 R121
172475	RC-CHIP 4.7K J 1/10W /0805		R175 R176
173479	RC-CHIP 47K J 1/10W /0805		R177 R178 R179 R180
101117	RC 100R J 1/4W 26MM	LL' SYSTEM	R185
173101	RC-CHIP 10K J 1/10W /0805	LL' SYSTEM	R186 R191
102338	RC 3.3K J 1/4W /6 52MM	LL' SYSTEM	R190 R192
172225	RC-CHIP 2.2K J 1/10W /0805	LL' SYSTEM	R193
101106	RC 100R J 1/4W 52MM	LL' SYSTEM	R194
179002	RC-CHIP 0R /1206	LL' SYSTEM	R195
179001	RC-CHIP 0R /0805 2*1.25		R203 R209 L109 R181
171332	RC-CHIP 330R J 1/10W /0805	HEADPHONE	R315 R316
172335	RC-CHIP 3.3K J 1/10W /0805		R317 R318 R320
171102	RC-CHIP 100R J 1/10W /0805		R321 R322
171471	RC-CHIP 470R J 1/10W /0805	CINCH	R328 R345
173123	RC-CHIP 12K J 1/10W /0805		R329 R330
291103	CC-CHIP 100PF J 50V /0805 N		R335
102685	CFR 6.8K J 1/4W /6 52MM		R354 R355
109474	CFR 4.7R J 1/2W /9 26MM		R358 R359
173101	RC-CHIP 10K J 1/10W /0805		R401 R404 R426 R428
172475	RC-CHIP 4.7K J 1/10W /0805		R402 R406 R407 R408 R434 R440
172225	RC-CHIP 2.2K J 1/10W /0805		R403
172273	RC-CHIP 2.7K J 1/10W /0805		R405 R511
172101	RC-CHIP 1K J 1/10W /0805		R409 R520
171471	RC-CHIP 470R J 1/10W /0805		R410 R411
171332	RC-CHIP 330R J 1/10W /0805		R417
171685	RC-CHIP 680R J 1/10W /0805		R425 R564
172823	RC-CHIP 8.2K J 1/10W /0805		R435 R438
173393	RC-CHIP 39K J 1/10W /0805		R437 R904
129236	RW 2.2R J 0.75W 73MM		R501
101471	CFR 470R J 1/2W /9 52MM		R502 R557
100220	CFR 22R J 1/2W 52MM		R503
174151	RC-CHIP 150K J 1/10W /0805		R505 R506
172183	RC-CHIP 1.8K J 1/10W /0805		R508 R512
119125	RM 1.2R J 1/2W 52MM	21"	R509
119153	RM 1.5R J 1/2W 52MM	20"	R509
170472	RC-CHIP 47R J 1/10W /0805	21"	R510
173101	RC-CHIP 10K J 1/10W /0805		R513 R423
102141	CFR 1K J 1/4W /6 26MM		R519

SPARE PARTS LIST

174104	RC-CHIP 100K J 1/10W /0805		R521
172823	RC-CHIP 8.2K J 1/10W /0805		R522
172225	RC-CHIP 2.2K J 1/10W /0805		R523
172394	RC-CHIP 3.9K J 1/10W /0805		R524
103224	CFR 22K J 1/4W 52MM		R526
110823	RMO 82R J 3W R:20		R554
100473	CFR 47R J 1/4W /6 52MM		R555 R921
113114	RM 10K J 1/2W 52MM		R558
119337	RMO 3.3R J 2W R:27.5 TAPE	⚠	R559
119478	RMF 0.47R J 1W	⚠	20" R560
119109	RNF 0.1R J 0.4W (UFLB) 52MM	⚠	21" R560
103136	CFR 10K J 1/4W /6 26MM		R562
172683	RC-CHIP 6.8K J 1/10W /0805	21"	R563
172823	RC-CHIP 8.2K J 1/10W /0805	20"	R563
101681	CFR 680R J 1/2W /9 52MM		R568
103475	CFR 47K J 1/4W /6 52MM		R705
102159	CFR 1.5K J 1/2W /9 52MM		R711 R713 R715 R716
101683	CFR 680R J 1/4W /6 52MM		R901
154216	NTC 5.1R M (S234R)		R901
154234	PTC 9R/3 PIN		R902
113683	RMO 68K J 1.5W 73MM		R903
173101	RC-CHIP 10K J 1/10W /0805		R905
114826	RM 820K %1 1/2W 52MM		R907 R908
172335	RC-CHIP 3.3K J 1/10W /0805		R909
114562	RM 560K %1 1/2W 52MM		R911 R922
174223	RC-CHIP 220K J 1/10W /0805		R912
115225	RMO 2.2M J 1/2W		R913
171822	CFR-CHIP 820R J 1/10W /0805		R914
173221	RC-CHIP 22K J 1/10W /0805		R915
172683	RC-CHIP 6.8K J 1/10W /0805		R917
173333	RC-CHIP 33K J 1/10W /0805		R918
115470	RM 4.7M J 1/2W 52MM	⚠	R920
113393	RM 39K J .5W 52MM	⚠	R950
171240	RC-CHIP 240R %1 1/10W /0805		R953
112131	RM 1.3K %1 1/4W 26MM		R954
109560	CFR 5.6R J 1/4W /3.2 52MM		R956
101106	CFR 100R J 1/4W 52MM		R957
120234	RMF 22R J 1/2W		R958
129109	RWF 0.1R J 0.75W 73MM	⚠	R959
119109	RNF 0.1R J 0.4W (UFLB) 52MM	⚠	R960
452521	IR RECEIVER TSOP 1838	⚠	S401
054261	FUSE 2.5AT (215 SER.)	⚠	S901
056749	SAW FILTER OFW G1985M	BG SYSTEM	SAW1
056070	SAW FILTER OFW K2966M	BG/DK SYSTEM	SAW1
056114	SAW FILTRE OFW J1980M I SISTEM	I SYSTEM	SAW1
056709	SAW FILTRE OFW K3953M	LL' SYSTEM	SAW1
056767	SAW FILTRE OFW K9456M	LL' SYSTEM	SAW2
031251	SCART SOCKET 14.1		SK101
031197	SCART SOKET HR-DM2441S-O		SK102
401047	TRN BC337-25		T01
401142	TRN-CHIP BC858B SOT23		T02
7KY136-PS1	TUNER ENV57D60G3 ASIMETRIK		T100
401141	TRN-CHIP BC848B SOT23		T101 T102 T103
401141	TRN-CHIP BC848B SOT23	LL' SYSTEM	T105 T108
400989	TRN BC558B	HEADPHONE	T315 T316
401142	TRN-CHIP BC858B SOT23		T317 T318 T319 T320
401141	TRN-CHIP BC848B SOT23		T321 T322
401142	TRN-CHIP BC858B SOT23		T401
401141	TRN-CHIP BC848B SOT23		T406 T501 T502 T402

SPARE PARTS LIST

401334	TRN STX112		T551
401332	TRN BU808DFI		T552
401397	TRN 2SC 2482		T701 T703 T705
401366	TRN BF421		T702 T704 T706
401424	TRN STP4NK60ZFP		T901
400901	TRN BC327-25		T902
401141	TRN-CHIP BC848B SOT23		T906
058013-EL6	FBT 20/21"	⚠	TR552
059038-EL1	SMPS 2021/SLOT TR/... 16.1	⚠	TR901
031882	CONN.HOUSING X2010 GREY	SINGLE SCART	X102
031730	CONN.HOUSING 2012 GREY	TWO SCARTS	X102
031730	CONN.HOUSING 2012 GREY		X103
031856	CONN.HOUSING X2003 BLACK		X104
031283	PIN HEADETR 2.54MM 9*1 YATIK		X315
031854	CONN.HOUSING X2003 GREY		X316
031323	CON.MKF19400-6-0-1010	SINGLE SCART	X317
031284	PIN HEADETR 2.54MM 12*1 YATIK	TWO SCARTS	X317
031857	CONN.HOUSING X2003 RED		X318
031860	CONN.HOUSING X2004 BLACK		X319
031858	CONN.HOUSING X2004 GREY		X320
031850	CONN.HOUSING 2"LI GREY		X501
031777	CON.HOUSING LOCKED 5/4		X551
A99553-AS	CABLE WITH HOLDER 3+1P L=380		X552
031530-02	INCHANG/CRT SOCKET ISHM23S-W		X703
31675	CON.HOUSING 2P MALE		X901
31672	CON.HOUSING 2P MALE RED		X902
7KY537-AS	CABLE HARNESS 3+3P L=380 HP.MOD.		X920
31165	KONN. CINCH YELLOW HOR.14		X921
31164	KONN. CINCH RED HOR.14.1		X922
31163	KONN. CINCH WHITE HOR.14.1		X923
31795	KONN.S-VHS		X924
7XY517-AS	CABLE HARNESS 3P L=360 HP.MOD.		X940
302297	DIODE Z. 3.9V 26MM		ZD406
303771	DIODE Z. UZT33V		ZD570
302298	DIODE Z. ZPD5.1V 26MM		ZD901
303735	MTZJ5.6B		ZD952
056520-SB1	CPT SEB A48ECR43X51		
056521-SB1	CPT SEB A51EER33X41		
620167-AS	DEGAUSSING COIL ASSY 20" BA	⚠	
621167-AS	DEGAUSSING COIL ASSY 21" BA	⚠	
5T1187F	RC BEKO TYPE SILV.14.1		
7TV187	RC A TYPE FUME 14.1		
6VM187	RC A TYPE SILVER 14.1		
7TK187	RC B TYPE FUME 14.1		
7GA107-AS	SPEAKER 8R.../7W(M) 50X90		
528107-AS	SPK.FOST.8R/7W PRJ-C POWER-		
7ZY107-AS	SPK.FT 8R/7W(NOM)(120X50MM)		

Please note that Product Part List Files should be investigated for the mechanical parts like cabinets, etc.

CHASSIS

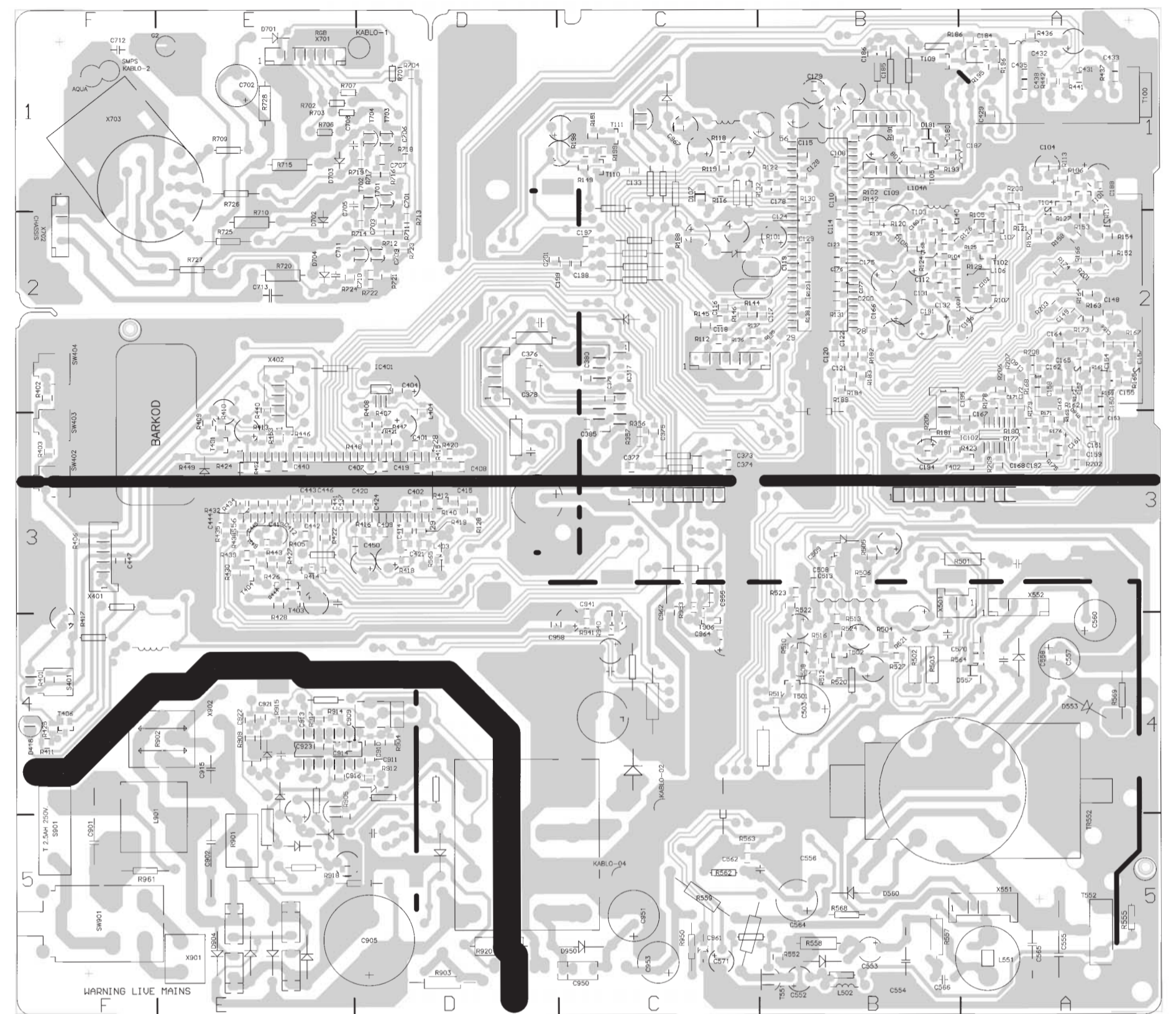
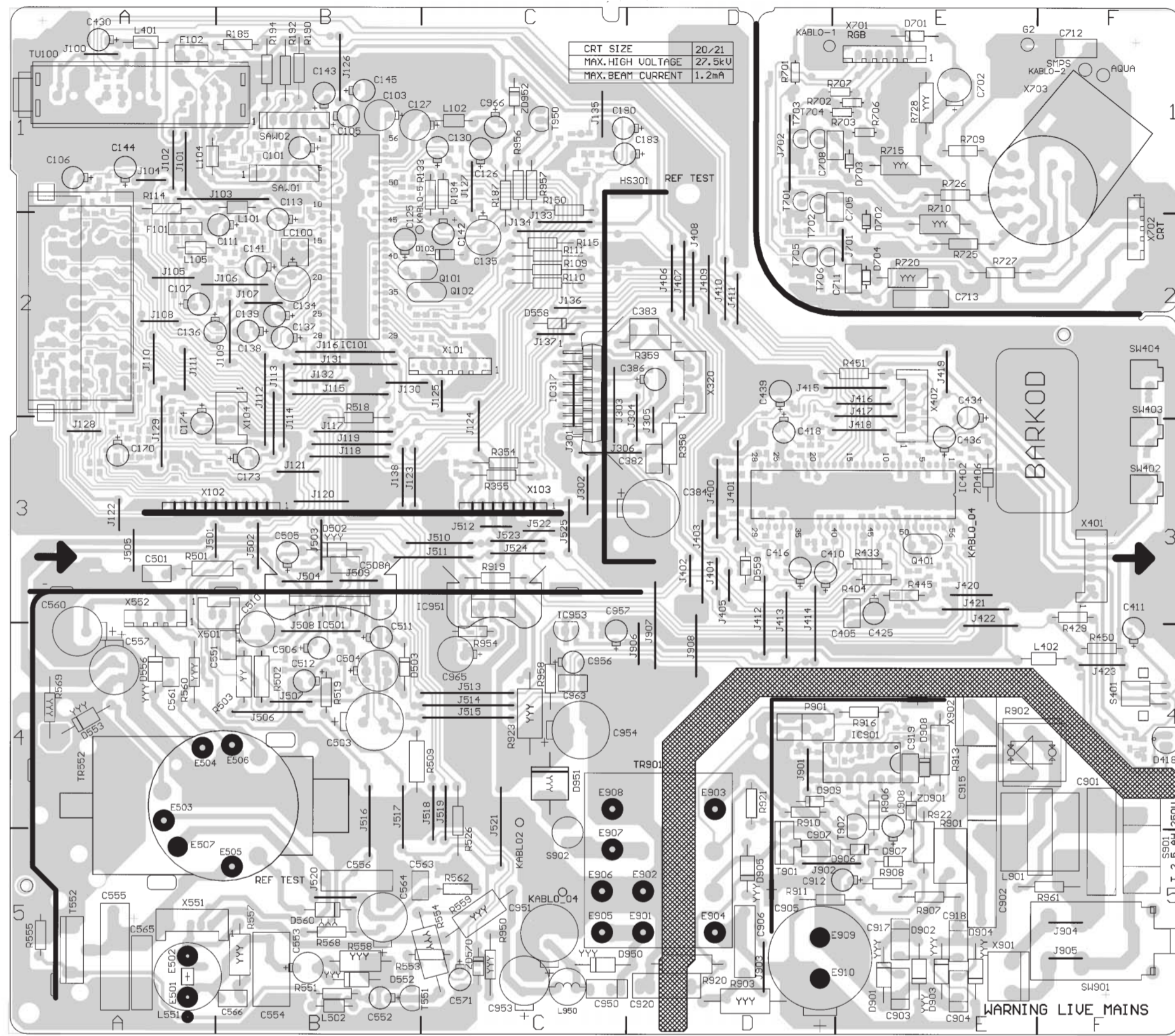

AV-MODUL (OPTIONAL)

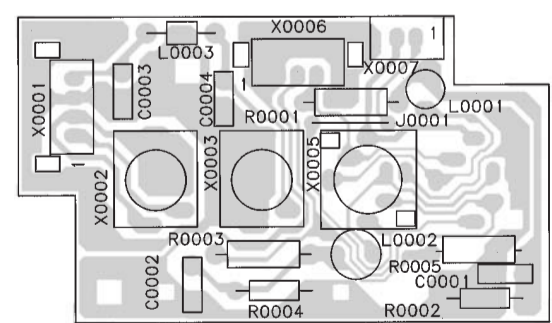

AV-MODUL (OPTIONAL)

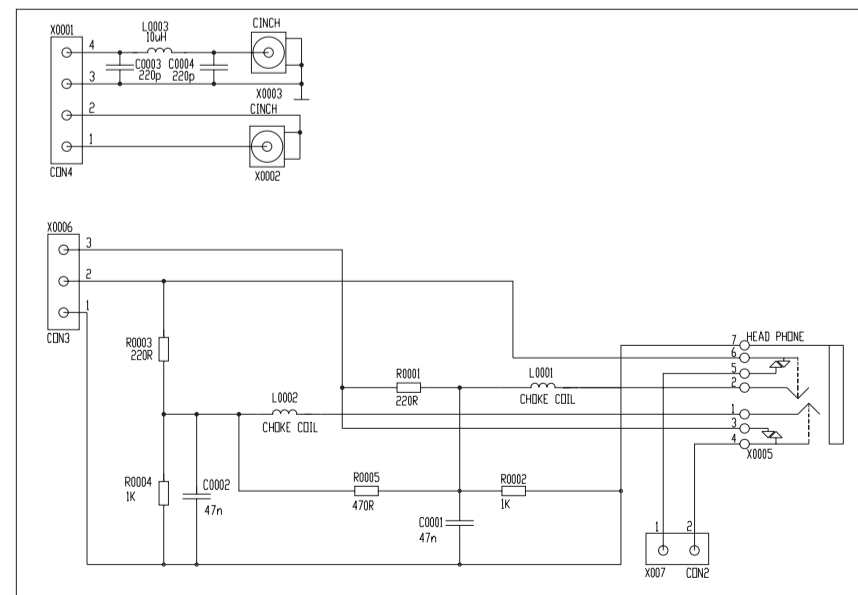

STEREO MODUL

